

EPILOG LASER

ENGRAVING | CUTTING | MARKING

EPILOGLASER.COM

MADEiNUSA

“THE HEART OF OUR
COMPANY IS **OUR PEOPLE.**
THE SOUL OF OUR COMPANY
IS **OUR CUSTOMERS.**
THE CORE OF OUR COMPANY
IS **OUR ENGINEERING.**”

MIKE DEAN - MR. EPILOG

In 1988 Epilog Laser became the very first manufacturer of small-format laser engraving systems. Epilog's revolutionary systems opened the world's eyes, not only to what could be accomplished with a laser, but how easy a laser is to use.

Epilog Laser has worked hard to become the **leader in the laser engraving, cutting and marking industry.** We are innovators. We are problem solvers. We are committed to designing and manufacturing the highest-quality laser systems, right here at our Golden, Colorado headquarters.

We've been in the laser business longer than anyone else and it shows - from creating the first laser to “print” directly from CorelDraw, to designing the first rotary attachment, to marketing the first large-format table, to manufacturing the first 100 watt laser system, Epilog is known for implementing useful features that enhance our customers' ability to work more efficiently and gain higher profits.

Explore our brochure to learn more about our made-in-the-USA laser systems and to find out why Epilog Laser has been the top choice of engravers for nearly 30 years.



MADEiNUSA GOLDEN, CO HEADQUARTERS

THE LEADER IN ENGINEERING

DESIGNED FOR EASE OF USE

- CHANGE SPEED/POWER ON THE FLY
- USE ANY WINDOWS-BASED SOFTWARE
- ETHERNET FOR TRUE NETWORKING

- DESIGNED & MANUFACTURED IN THE USA
- OVER 20,000 LASER TUBES ON THE MARKET
- ON-BOARD PROCESSING AND MEMORY

HIGHEST-QUALITY COMPONENTS

LOW LIFETIME COSTS

- NO EXCLUSION WARRANTY
- LOW TUBE RECHARGE COST
- DESIGNED FOR EASY MAINTENANCE/CLEANING

- HIGHEST-RESOLUTION PHOTO ENGRAVING
- FASTEST ENGRAVING SPEEDS
- HIGHEST-CONTRAST GRAYSCALE ENGRAVING

HIGHEST ENGRAVING PERFORMANCE

CHOOSE YOUR LASER SOURCE

CO₂ LASERS: MATERIAL VERSATILITY

If you're looking for a laser that can engrave and cut a wide variety of materials, our CO₂ laser line may be the right choice for your application. A CO₂ laser system can engrave on all kinds of materials, including wood, acrylic, rubber, plastic, and more.

From our desktop-sized Epilog Zing 16 with a 16" x 12" (406 x 305 mm) engraving table, to our top-of-the-line Fusion M2 40 with a large 40" x 28" (1016 x 711 mm) work area, we have a laser system that can meet your needs. Each of our systems feature our industry-leading engraving quality, the fastest engraving speeds at the highest resolutions, and the versatility to engrave and cut a wide variety of materials.

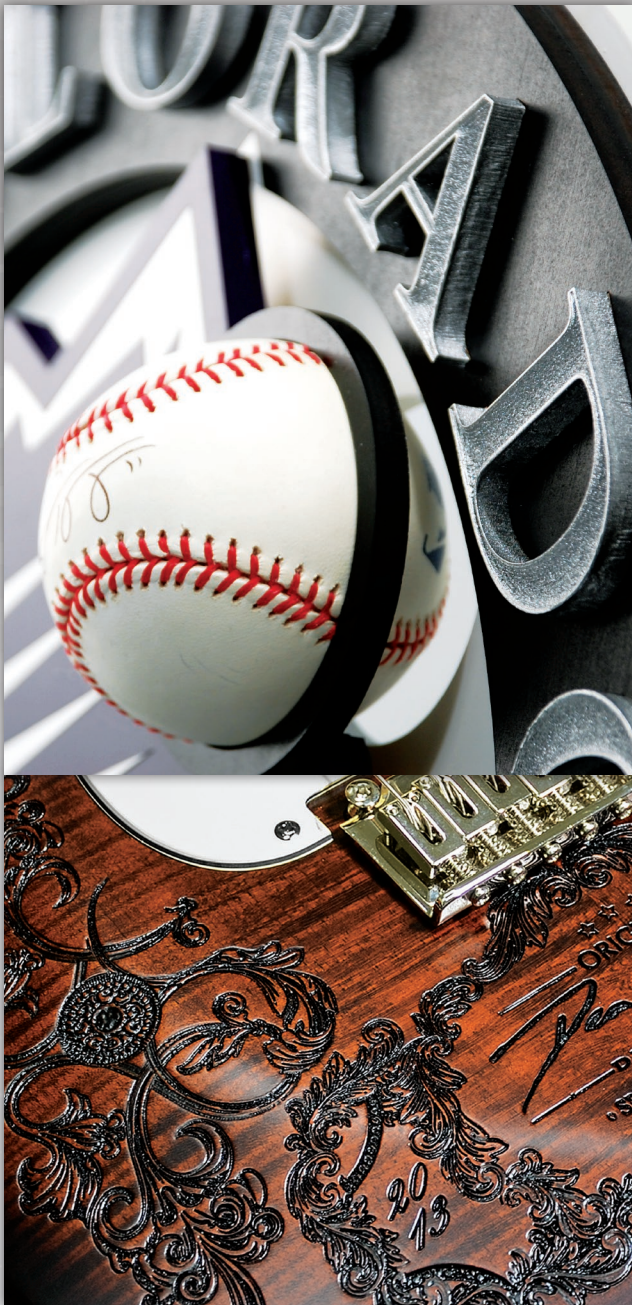

| | Engrave | Cut |
|-------------------|---------|-----|
| Wood | • | • |
| Acrylic | • | • |
| Glass | • | |
| Coated metals | • | |
| Ceramics | • | |
| Delrin | • | • |
| Cloth | • | • |
| Leather | • | • |
| Marble | • | |
| Matboard | • | • |
| Melamine | • | • |
| Paper | • | • |
| Mylar | • | • |
| Pressboard | • | • |
| Rubber | • | • |
| Wood veneer | • | • |
| Fiberglass | • | • |
| Painted metals | • | |
| Tile | • | |
| Plastic | • | • |
| Cork | • | • |
| Corian | • | • |
| Anodized aluminum | • | |
| Twill | • | • |
| Stainless steel | ‡ | |
| Brass | ‡ | |
| Titanium | ‡ | |
| Bare metal | ‡ | |

‡ CO₂ lasers will mark bare metals when coated with a metal marking solution. For more information, call +1 303-277-1188.

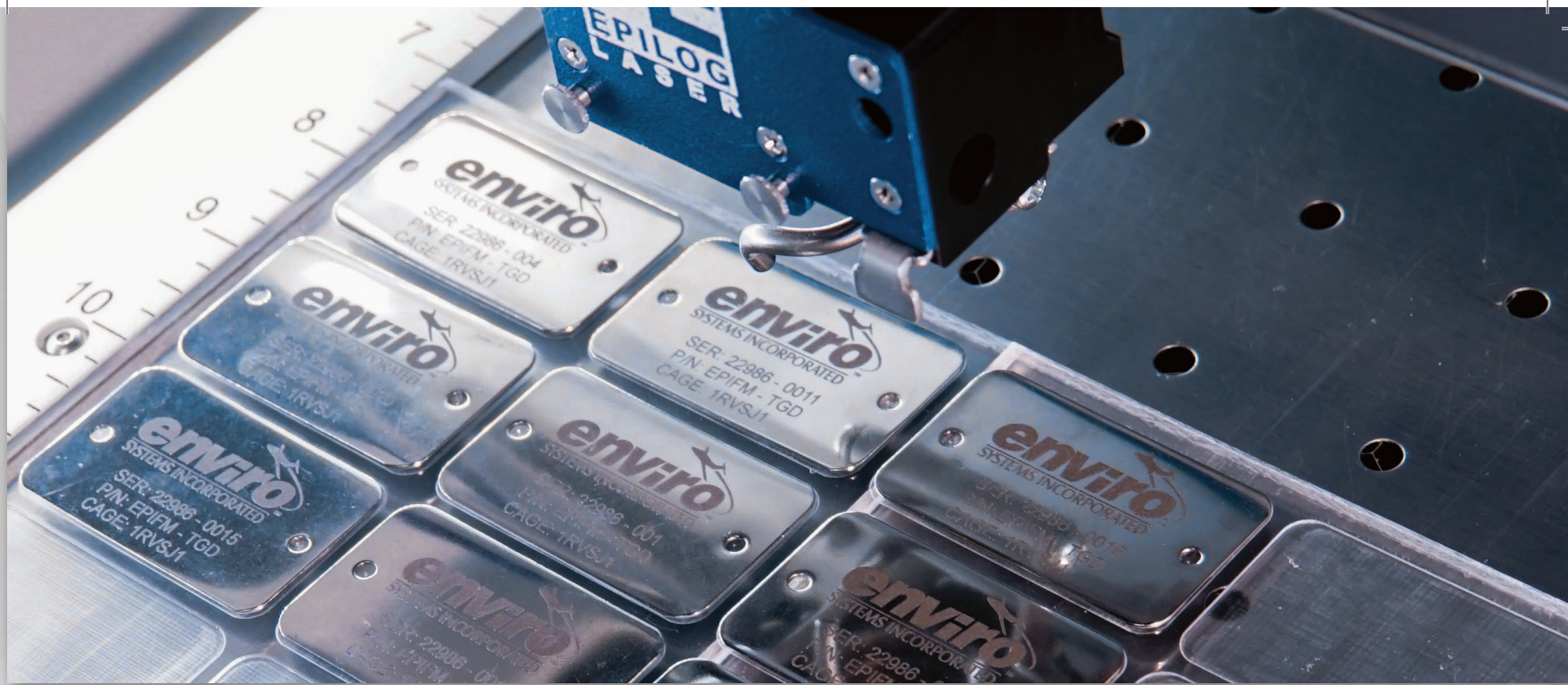

FIBER LASERS: INDUSTRIAL MARKING

The second type of laser in Epilog's product line is our fiber laser systems. Featuring an air-cooled ytterbium fiber laser source, these are the ideal systems for direct metal etching and marking, as well as marking engineered plastics.

Epilog's fiber systems feature two beam delivery options: our traditional flying-optic (flat-bed design) and a galvo-mirror design. While the flying-optic fiber systems provide a large engraving area, Epilog's galvo system, the Epilog G2, allows you to engrave at ultra-high speeds and with great precision.

COMPATIBLE MATERIALS

| | | | |
|-----------------------------------|---|-------------------------------|--------------------------|
| 17-4 PH stainless steel | Ceramics, metal-plated | Metal-plated ceramics | Silicon carbide |
| 303 stainless | Clear coat anodized aluminum | Molybdenum | Silicon steel |
| 4043 steel | Cobalt chrome steel | Nickel-plated 1215 mild steel | Silicon wafers |
| 6061 aluminum | Copper | Nickel-plated brass | Stainless steel 303 |
| ABS (black/white) | Compacted powder iron-phosphate coating | Nickel-plated gold | Stainless steel 17-4 PH |
| Aluminum, 6061 | DAP- Diallyl Phthalate | Nickel-plated Kovar | Steel 4043 |
| Aluminum, yellow chromate | Delrin, colored (black/brown) | Nickel-plated steel | Steel, machine tool |
| Bayer 2807 Makrolon polycarbonate | GE Plastics polycarbonate resin | Nylon | Various inconel metals |
| Bayers bayblend FR110 | 121-R | PEEK, white | White PEEK |
| Black/white ABS | Glass filled PEEK | Polybutylene Terephthalate | Yellow chromate aluminum |
| Black/white polycarbonate | Glass filled Teflon | Polycarbonate, (black/white) | Zinc plated mild steel |
| Brass | Hard coat anodized aluminum | Polycarbonate resin 121-R | And many more! |
| Brushed aluminum | Inconel metals (various) | Polycarbonate, Bayer 2807 | |
| Carbon fiber | Machine tool steel | Polysulfone | |
| Carbon nanotube | Magnesium | Rynite PET | |
| Ceramics | Makrolon | Santoprene | |

IMAGINE ► DESIGN ► CREATE:

Electronics Engraving
Wood Engraving & Cutting
Marble & Stone Etching
Glass Etching
Corporate Giveaways
Sporting Goods
Acrylic & Wood Signage
Wedding Memorabilia

Nameplates & Desksets
Appliqués
Toys & Games
Wooden Models
Photo Albums
Holiday Decorations
Laser Cut Cards & Invitations
Guitar Inlays

Custom Jewelry
Corporate & Sporting Awards
Acrylic Plaques
Photo Frames
One-of-a-Kind Gifts
Engraved Mirrors
Architectural Models
Custom Pet Tags



CUSTOM PRODUCTS

Inlaid Signage
3D Models
Engraved Denim Jeans
Photo Engraving
Barcode Engraving
Logo Engraving on Parts
Tool Identification
Medical Part Marking

Etched Business Cards
Wine Bottle Etching
Phone Customization
Photo Etching
Holiday Ornaments
Cloth Etching
Paper Invitations
Laptop Customization

Memorials
Home Decor
Marble Flooring
Cabinetry
Product Marking
Industrial Etching
And much more!



SOFTWARE

PRINT DIRECTLY FROM THE SOFTWARE OF YOUR CHOICE

Our open-architecture software design allows you to use almost any Windows®-based software to design your projects, so you're spending your time learning to engrave and cut, not learning new software. CorelDRAW, Illustrator, Photoshop, AutoCAD, and many other programs can all be used to create your designs.

For the quickest job setup in the industry, create your graphic in the software of your choice and print it directly to the laser. Our Laser Dashboard™ Print Driver allows you to print directly from the software without using a third party application.

JOB MANAGER SOFTWARE

For enhanced job organization, you can send your file to the Epilog Job Manager. From one easy-to-use software application, you can access any job you have ever sent to the laser, view the settings you used on any past job, re-run projects, and access your material database.

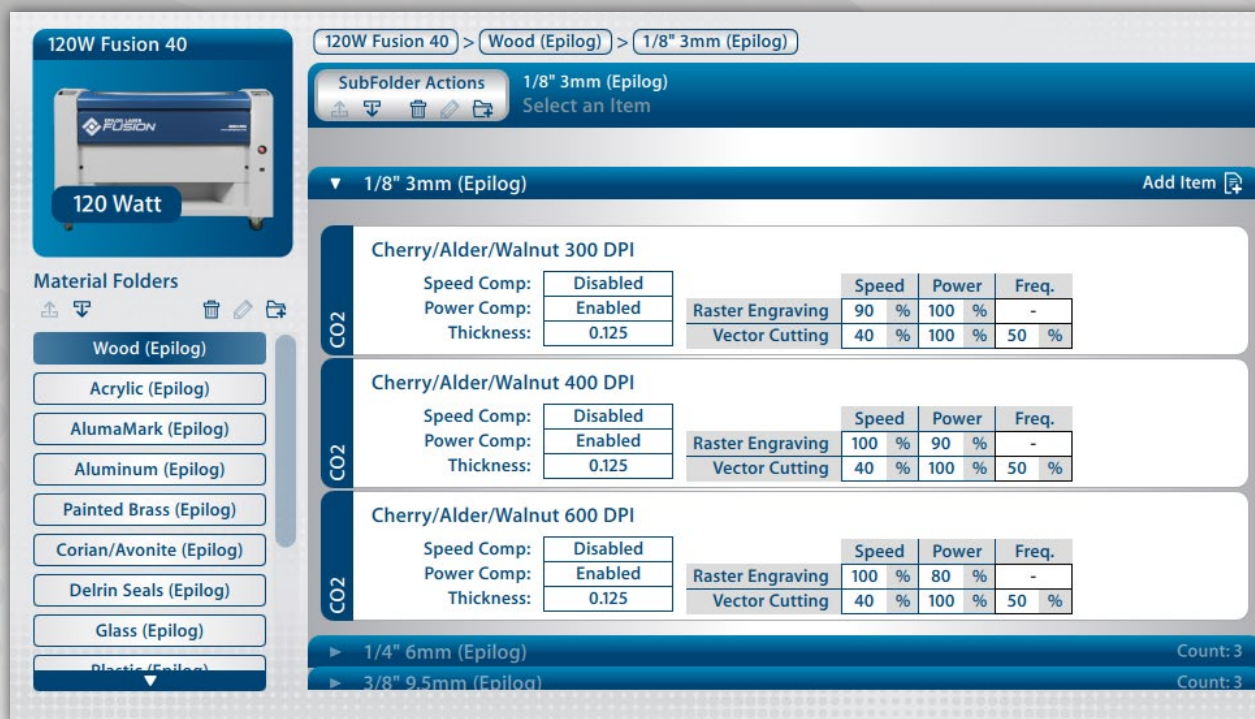

CREATE A PROJECT

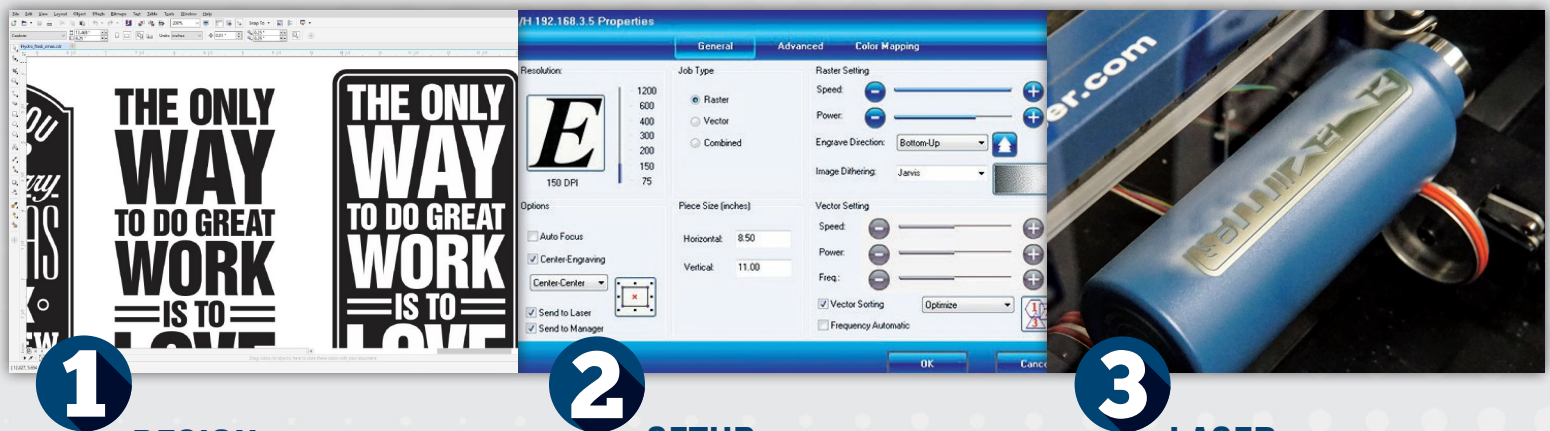

1

DESIGN

Create a new page in your graphic software. Import or create your own custom design.

2

SETUP

Send your design to the laser. In the print driver you'll select the laser parameters you want to use, or select a preset material setting from Epilog's extensive database.

3

LASER

Select your file at the laser, put your engraving material in the machine, shut the door, and press GO. The laser will do the rest!



SETUP & USE

NETWORK YOUR LASER

All Epilog Laser systems are network devices with both **Ethernet** and **USB** connections, or connect **wirelessly** through a router. With true Ethernet connectivity you have the most reliable and quick data transfer available with the ability to network multiple computers to a single system or multiple lasers to a single computer.



SIMPLE POSITIONING OPTIONS

- Simply place your item at the top left corner of the table for most objects.
- Or for uniquely-shaped items, use the Red Dot Pointer to set a new home position.
- For quick and accurate engraving placement use our Center Engraving feature.
- Cylindrical items can be placed on the Rotary Attachment.

MAINTENANCE

The non-contact process of laser engraving keeps maintenance to a minimum. Simply clean the optics regularly and keep the machine free of dust and debris to keep your laser running for a very long time. The only consumable on the system is our metal laser tubes with ceramic components, which feature the longest lifespans in the industry and lowest replacement costs.

HOW DO I CHOOSE MY WATTAGE?

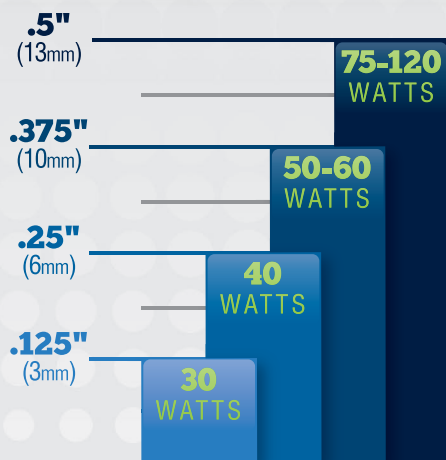

SUGGESTED WATTAGE FOR CUTTING MATERIALS

Higher wattage lasers can cut through thicker materials in a **single pass**.

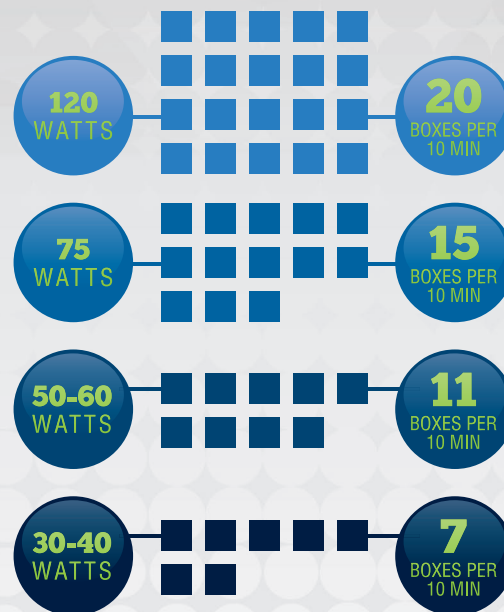

ENGRAVING SPEED

Engrave at higher speeds when etching certain materials (wood, glass, rubber, etc).

ZING STARTER SERIES

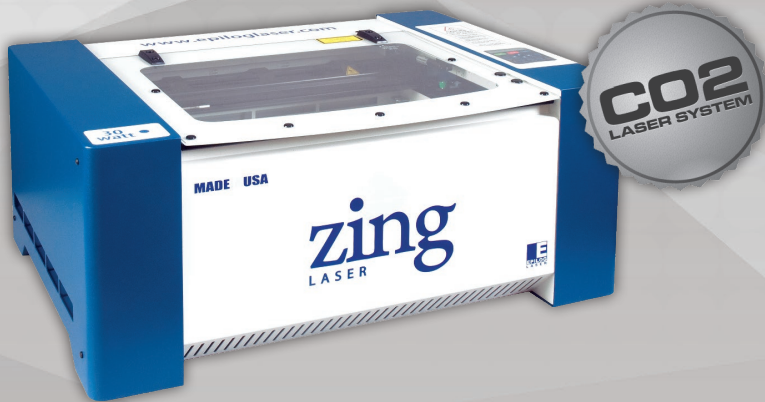

ZING 16

Small-size, entry-level laser system that is perfect for starting a business or to operate out of your home, office or school.

- 16" x 12" x 4.5" (406 x 305 x 114 mm) work area
- 30 or 40 watt CO₂ laser
- Affordable pricing for the entry-level user



ZING 24

Larger work area and more features make this laser an affordable choice for those needing more features than an entry-level machine.

- 24" x 12" x 7.75" (610 x 305 x 197 mm) work area
- 30, 40, 50 or 60 watt CO₂ laser
- Radiance™ High-Resolution Optics for a smaller laser spot size across the table

INCLUDED FEATURES

Zing 16 Zing 24

| | | |
|--|---|---|
| Made-in-the-USA Quality: Designed, engineered, and built in Golden, CO. | • | • |
| Epilog Job Manager: Job management and workflow software - easily organize, edit, save and print. | • | • |
| Laser Dashboard™: Our print driver where you can choose from many engraving features. | • | • |
| Waveguide Laser Tubes: Long-lasting, all-metal tubes for the best engraving quality. | • | • |
| High-Speed Stepper Motors: Faster stepper motors that provide high-resolution engravings. | • | • |
| Raster/Vector Color Mapping: Change your speed and power by using color settings. | • | • |
| Air Assist : Remove heat and combustible gases from the cutting surface. | • | • |
| 3D and Stamp Engraving Settings: Etch and cut stamps or create 3D curves on your engraving. | • | • |
| Networking Choices: USB and Ethernet connections, or connect wirelessly with a router. | • | • |
| Lenses Rated to 500 Watts: Highest-quality lenses provide long life and higher resolutions. | • | • |
| Moveable Home Position: Engrave oddly-shaped items easily by setting a new home position. | • | • |
| Red Dot Pointer: Provides a visible laser beam to help position your projects. | • | • |
| Super-Silent™ Cooling Fans: Quiet operation by reducing the time fans are turned on. | • | • |
| Radiance™ Beam-Enhancing Optics: The most consistent beam quality over a larger engraving table. | | • |
| Easy-Access, Drop-Down Door: Front-access door for the laser system. | | • |
| Compatibility with Rotary Attachment: Engrave cylindrical objects with the optional rotary. | | • |

INCLUDED

VISIBLE LASER BEAM FOR POSITIONING

While the CO₂ laser beam in the system is invisible, the system's Red Dot Pointer allows you to see the exact engraving or cutting location on your product. Use this popular feature to preview your engraving or cutting position on uniquely-shaped items or to set a new home position anywhere on the table.

LONG-LIFE LASER TUBES WITH FASTER SWITCHING RATES

Laser tubes designed and manufactured by Epilog Laser combine long-life productivity with ease of maintenance. Our patented Waveguide™ laser technology operates with faster switching rates and a smaller bore which allows us to engrave even the most-detailed images at the fastest speeds.

HIGH-SPEED STEPPER MOTORS

The Zing Starter Series utilizes high-speed stepper motors to drive the laser positioning. Designed for affordability and quality, these stepper motors provide the high-quality engraving results that you've come to expect from all of Epilog's laser engraving and cutting systems.

OPTIONAL

VECTOR GRID

When you are cutting through materials, the Zing's Vector Grid raises the material you're cutting off the table, which dramatically reduces back-side burning on any material you cut. The air space below the vector grid is connected to the exhaust, so smoke is removed not only from the top side, but also from the underside of the material.

ZING 24 ROTARY ATTACHMENT

Engrave wine bottles, mugs, glasses, flashlights or any other cylindrical item up to 5.25" (133.4 mm) in diameter on the Epilog Zing 24 Laser. Intuitive and easy to use, you can switch from one glass to the next in seconds. In addition, our proprietary design provides accurate image scaling, so there's no need to input diameter or circumference calculations.

AIR COMPRESSOR

Attach Epilog's Air Compressor to the Air Assist Curtain to direct a constant stream of air over the work surface. This high-quality compressor ensures you get excellent cutting results every time you use your system by directing 30 psi (2.07 bar) of air through the Air Assist assembly.

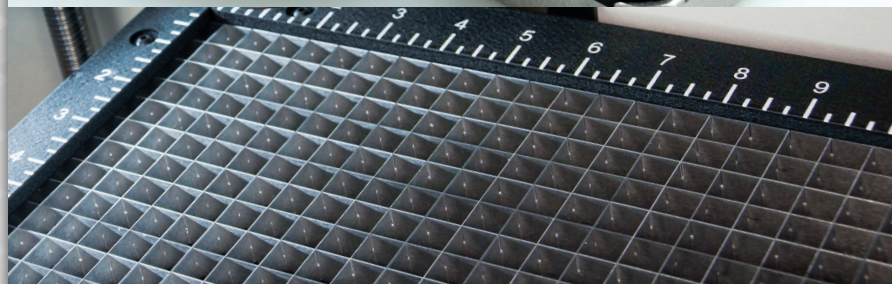
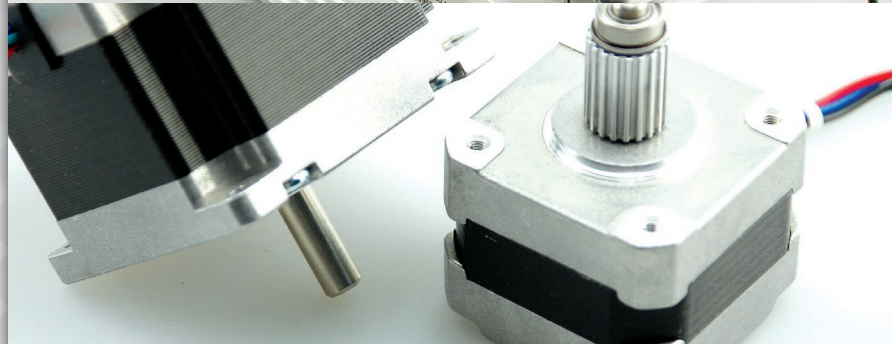
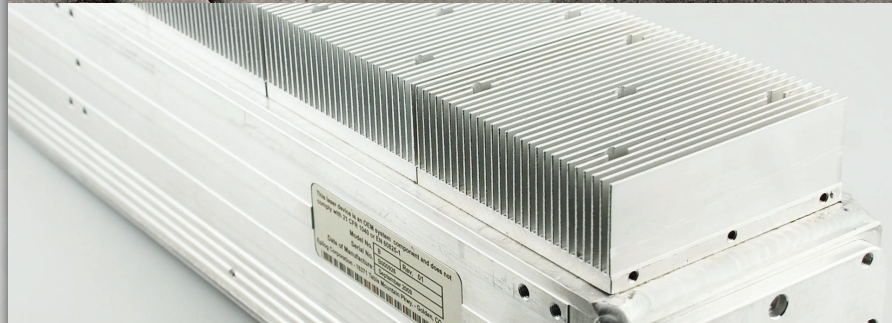
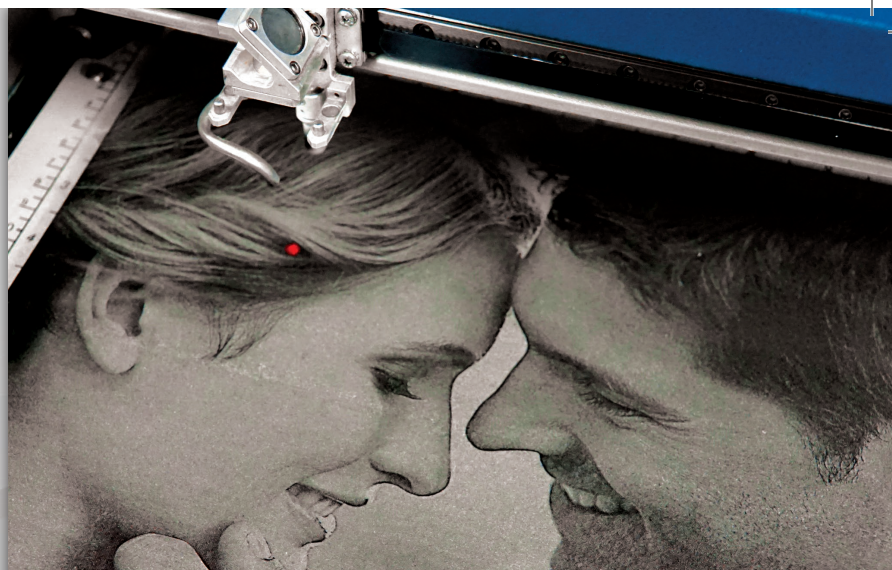

LEGEND LASER SERIES

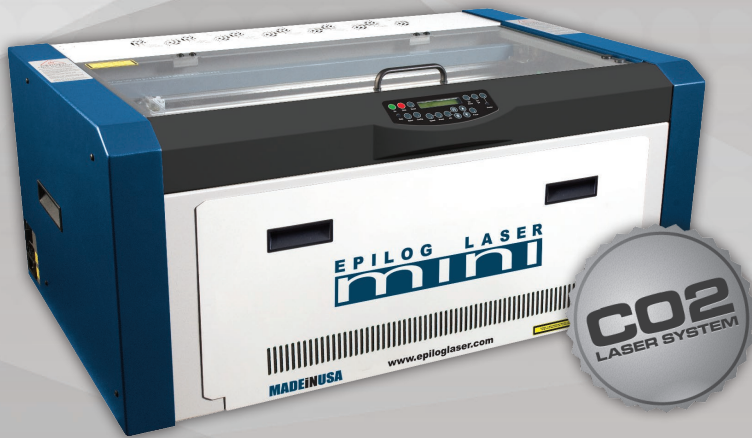

MINI 18 & 24

Looking for a system with faster engraving times than the Starter Series, but that still offers a small work area? The EpiLog Mini 18 and 24 Lasers are an ideal way to move into our Legend Series.

- High-speed servo motors and linear encoder driven
- Automatic focusing to the perfect focal distance from the lens
- 1200 dots per inch engraving
- 18" x 12" x 4" (457 x 305 x 102 mm) or 24" x 12" x 5.5" (610 x 305 x 140 mm) engraving area
- 30 or 40 watt CO₂ laser - Mini 18
- 30, 40, 50, or 60 watt CO₂ laser - Mini 24



HELIX

For engravers looking to work with larger pieces or products, the EpiLog Helix is an ideal choice. The Helix's generous 24" x 18" x 8.5" (610 x 457 x 216 mm) work area will allow you to engrave multiple pieces as well as process thicker materials.

- Radiance™ High-Resolution Optics for a smaller laser spot size across the table
- Easy-Access Drop-Down Door for loading from the front of the machine
- Easy-Access Storage Stand to easily move your laser throughout your office, workshop or school
- 30, 40, 50, 60 or 75 watt CO₂ laser



FIBERMARK 24

Our small-format fiber laser system, the FiberMark 24, allows you to etch directly into metal and mark many plastics. The FiberMark 24 is our original fiber laser system and is the first flying-optic fiber laser system ever developed.

- Drop-down front door for inserting large parts or a tray of tools
- Ability to create etched, annealed, and polished marks
- 1200 dots per inch engraving
- 24" x 12" x 5" (610 x 305 x 127 mm) work area
- 20, 30, or 50 watt fiber laser

INCLUDED FEATURES

Mini 18
Mini 24
Helix
FiberMark 24

| | | | | |
|--|---|---|---|---|
| CO2 Waveguide Laser Tubes: Long-lasting, metal tubes for the best engraving quality. | • | • | • | |
| Fiber Laser Source: Etches directly into bare metal and marks plastics. | | | | • |
| High-Speed Servo Motors: Faster servo motors that provide high-resolution engraving. | • | • | • | • |
| Laser Dashboard™: Our print driver where you can choose from many engraving features. | • | • | • | • |
| Epilog Job Manager: Job management and workflow software - easily organize, edit, save and print. | • | • | • | • |
| Linear Encoders: Highest-quality engraving from the most precise motion control system. | • | • | • | • |
| Metal Bearings: Stainless steel bearings designed to last the life of the machine. | • | • | • | • |
| Kevlar Belts: Our precision drive belts are made from B-style Kevlar for superior longevity. | • | • | • | • |
| Made-in-the-USA Quality: Designed, engineered and built in Golden, CO. | • | • | • | • |
| Raster/Vector Color Mapping: Change your speed and power by using color settings. | • | • | • | • |
| Air Assist: Remove heat and combustible gases from the cutting surface. | • | • | • | • |
| Auto Focus: Automatically focus the engraving table to the correct focal distance. | • | • | • | |
| 3D and Stamp Engraving Settings: Etch and cut stamps or create 3D curves on your engraving. | • | • | • | |
| Networking Choices: USB and Ethernet connections, or connect wirelessly with a router. | • | • | • | • |
| Lenses Rated to 500 Watts: Highest-quality lenses provide long life and higher resolutions. | • | • | • | |
| Moveable Home Position: Engrave oddly-shaped items easily by setting a new home position. | • | • | • | • |
| Red Dot Pointer: Provides a visible laser beam to help position your projects. | • | • | • | • |
| Compatibility with Rotary Attachment: Engrave cylindrical objects with the optional rotary. | • | • | • | • |
| Integrated Vector Cutting Grid: Lifts the piece being cut to reduce back-side burning. | • | • | • | |
| Integrated Vacuum Table: Holds down thin sheet stock. | • | • | • | • |
| Super-Silent™ Cooling Fans: Quiet operation by reducing time fans are turned on. | • | • | • | • |
| Permanent Job Storage: Store as many as 10 jobs up to 2MB in size. | • | • | • | • |
| Job Delete at the Laser: Delete old jobs to keep your laser job queue organized. | • | • | • | • |
| Vector Table Crumb Tray: Easily dispose of debris from under your Vector Cutting Grid. | • | • | • | |
| Easy-Access Drop-Down Door: Front access door for the laser system. | • | • | • | • |
| Radiance™ Beam-Enhancing Optics: Higher-resolution optics for detailed engraving. | | • | • | |
| Easy-Access Storage Stand: Wheeled, free-standing cart for easier access. | | | • | • |



HIGHER PERFORMANCE OPTICS SYSTEM

Our Radiance™ High-Resolution Optics help us produce the sharpest laser beam in the industry, which provides the most detailed engraving and cutting results available. After the laser beam leaves the laser tube, it passes through a set of two optical components that straighten and expand the beam before focusing the laser. This set of optics dramatically reduces beam divergence and produces a laser beam that maintains its size and straightness across the entire engraving table. (Excluded from Mini 18 and FiberMark 24)

64 MB OF RAM IN THE SYSTEM

With 64 MB of RAM in every Legend Series system, you can conveniently organize your print jobs, ensuring data integrity. Unlike many laser systems that rely on a USB connection to keep their laser system running, memory in the Legend Series systems guarantees you won't have to worry about the computer freezing, the USB cord being too short, or even the screen saver turning on and ruining your job. You can even save your most common jobs at the laser and complete jobs directly from the Control Panel.

INTEGRATED VECTOR CUTTING GRID AND VACUUM TABLE

The Vector Cutting Grid included with the Legend Series systems is a robust 1" (25.4 mm) thick. Simply remove the Task Plate and place the Vector Cutting Grid in the system to dramatically reduce backside burning of the material being cut. The Vacuum Hold-Down Table uses the air from under your exhaust fan to hold thin sheet stock flat.

INCLUDED

HIGH PRECISION SERVO MOTORS AND STAINLESS STEEL BEARINGS

Firing the laser in the right place at the right time is the concept behind the Legend Accupoint™ Motion Control Technology. While it's easy to see the extraordinary level of detail in our engravings at any resolution, the engineering behind our equipment is what makes this accuracy possible. At 1200 dpi, the entire motion control system is moving in increments as small as .0008" (.02 mm), which is the result of a special blend of high-quality components available only in the Legend Series.

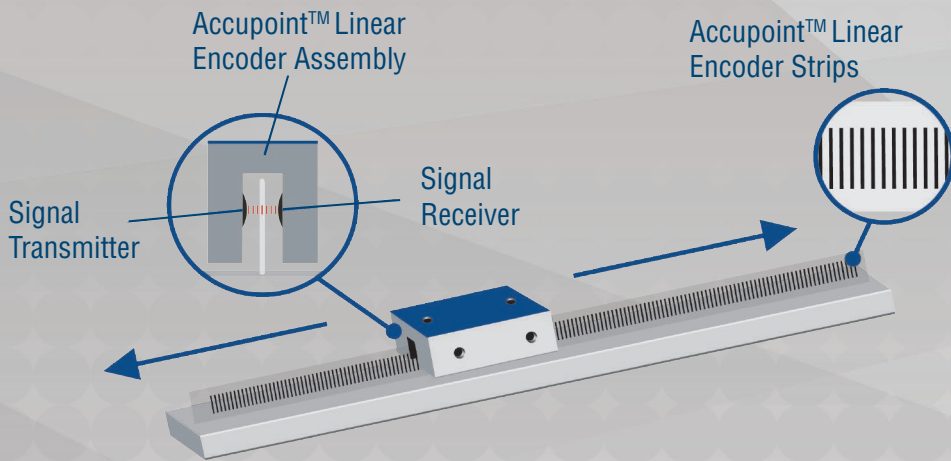

LINEAR ENCODER

The Legend Series' linear encoders provide critical timing information that synchronizes the motion control system to the firing of the laser. Mounted directly to the moving carriage, the linear encoders provide crisp, clean images, even at the highest speeds.

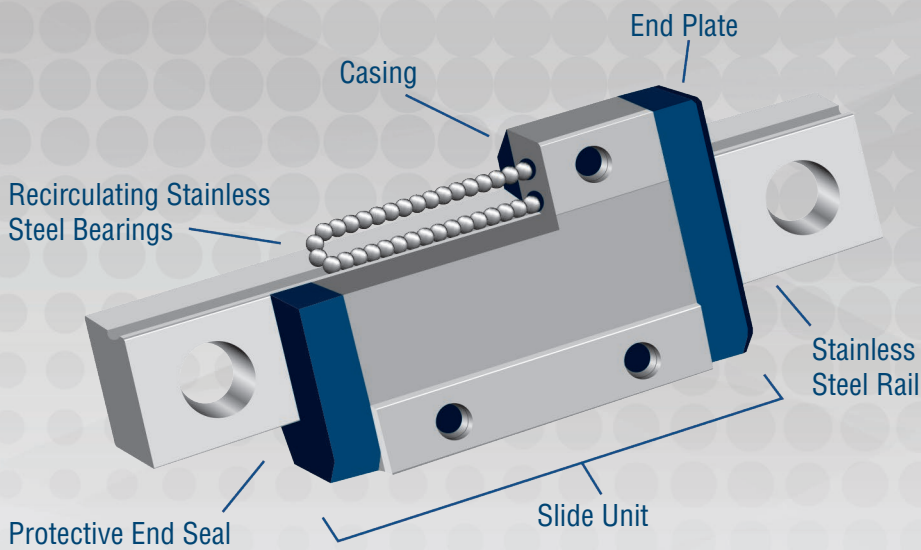

LONG-LASTING STAINLESS STEEL BEARINGS

Each slider unit is built with at least 64 stainless steel bearings. Our long-lasting bearings can operate at the highest speeds, day in and day out, without worry about failure, replacement, or the inevitable wobble that less robust bearing systems experience.



SERVO MOTORS

The ability of a motor to move smoothly at high speeds is a key component to the Accupoint system. Closed-loop, DC servo motors are known for their incredibly fast acceleration and deceleration speeds, as well as their ability to operate without the cogging seen in less accurate motors.

OPTIONAL

ROTARY ATTACHMENT

This handy attachment gives you the ability to engrave mugs, bottles, glasses, flashlights, vases and other cylindrical items.

Designed for ease of use, you can quickly engrave a glass, move to a wine bottle, then to a vase without removing the attachment. Place your item on the rotary and start engraving!

AIR COMPRESSOR

Epilog's optional Air Compressor is available to work with the included Air Assist feature of the laser systems. Direct a constant stream of air to your cutting surface to remove heat and combustible gases from the work area.

This high-quality air compressor unit feeds 30 psi (2.07 bar) of air through the Air Assist structure, giving you the best cutting results available. The rubber, vibration-dampening feet reduce the noise level of the compressor.

MINI LASER STAND

If you prefer to have a free-standing Mini 18 or 24, you can add this wheeled cart, specially designed for the Mini laser line. It will allow you to quickly and easily move your machine throughout your work environment.

VECTOR PIN TABLE

The Vector Pin Table incorporates moveable pins designed to raise and support the areas of a piece of material that won't be cut. This helps ensure you receive the cleanest laser cut edges from your laser system.

1.5" LENS: HIGH RESOLUTION ENGRAVING

Although the standard 2.0" lens on the Legend Series provides amazing detail (including the stunning Aztec calendar sample), our 1.5" lens assembly has been designed for the highest resolution engraving and etching of extremely small fonts.

4.0" LENS: MINI 24 AND HELIX LASER

The 4.0" lens produces a focused beam over a greater vertical distance, which makes it ideal when engraving within a recessed area of a product, such as inside a bowl or plate.

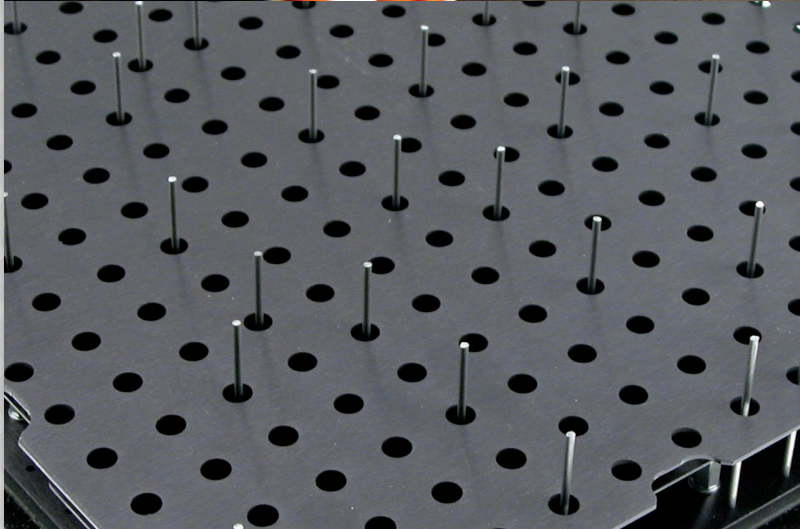

FUSION M2 LASER SERIES

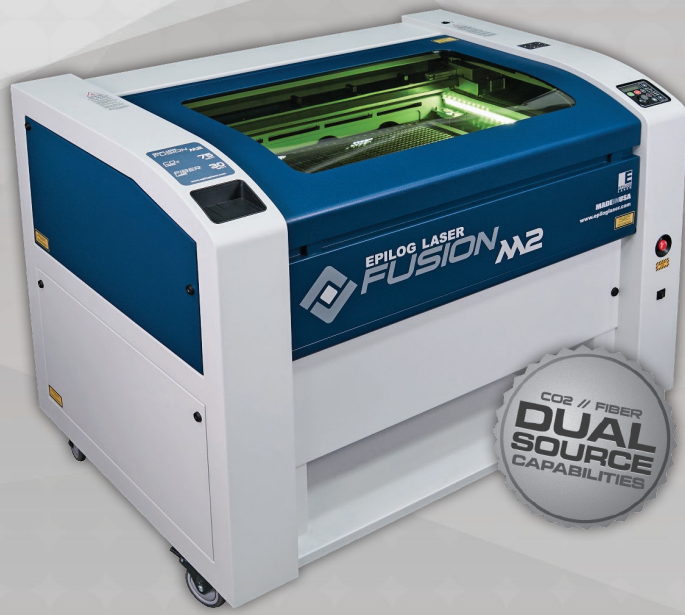

FUSION M2 32

The Fusion M2 32 is available in CO₂, fiber or dual-source configurations and is outfitted with our new motion control system for higher speeds and the best edge quality when cutting. We're excited for customers to try out our premier laser with unmatched speeds and cutting quality.

- Available in CO₂, fiber or dual-source configurations
- 32" x 20" (812 x 508 mm) work area
- 30, 40, 50, 60, 75 or 120 watt CO₂ laser
- 20, 30, or 50 watt fiber laser
- Robust table lifts 100 lbs (45.4 kg)
- Drop-down front door and removable exhaust panel

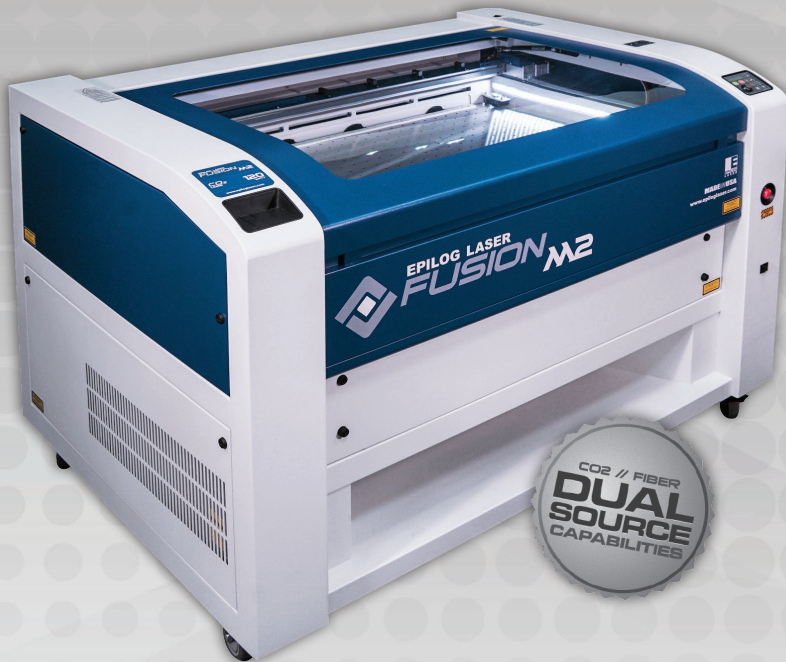

FUSION M2 40

The largest system in our product line is the Fusion M2 40 laser. You'll be able to work with the largest products that you need to engrave.

- Available in CO₂, fiber or dual-source configurations
- Our largest engraving and cutting table
- 40" x 28" (1016 x 711 mm) work area
- 30, 40, 50, 60, 75 or 120 watt CO₂ laser
- 20, 30, or 50 watt fiber laser
- Robust table lifts 100 lbs (45.4 kg)
- Drop-down front door and removable exhaust panel





INCLUDED FEATURES

Fusion M2 32
Fusion M2 40

| | | |
|---|---|---|
| Made-in-the-USA Quality: Designed, engineered and built in Golden, CO. | • | • |
| Dual Source Capabilities: Optional CO ₂ and Fiber laser sources in one system. | • | • |
| Epilog eView™ Camera Module: Incredibly accurate laser die cuts around printed images. | • | • |
| Laser Dashboard™: Our print driver where you can choose from many engraving features. | • | • |
| PC Driver: Print to the laser directly from your PC. | • | • |
| Joystick Controls: Move the laser head and run the laser directly from the control panel. | • | • |
| LED Lighting: Bright LED lighting inside the machine. | • | • |
| Strong Steel Chassis: 10x more rigid than any of our other systems. | • | • |
| Rotary Encoders: Extremely accurate at 16,000 counts per revolution. | • | • |
| Self-Lubricating Bearings: Stainless steel bearings designed to last the life of the machine. | • | • |
| Precision Drive Belts: Strong drive belts with Kevlar on the x-axis and steel cord on the y-axis. | • | • |
| Pneumatic Assist Crash Bar: Protects x-axis from user error if table rises too high. | • | • |
| Laminar Air Flow: Streamlined air flow for the most efficient smoke and vapor removal. | • | • |
| High-Speed, Brushless DC Servo Motors: Withstands the most rigorous engraving jobs at high speeds. | • | • |
| Raster/Vector Color Mapping: Change your speed and power by using color settings. | • | • |
| Air Assist: Remove heat and combustible gases from the cutting surface. | • | • |
| 3D and Stamp Engraving Settings: Etch and cut stamps or create 3D curves on your engraving. | • | • |
| Networking Choices: USB and Ethernet connections, or connect wirelessly with a router. | • | • |
| Lenses Rated to 500 Watts: Highest-quality lenses provide long life and higher resolutions. | • | • |
| Moveable Home Position: Engrave oddly-shaped items easily by setting a new home position. | • | • |
| Red Dot Pointer: Provides a visible laser beam to help position your projects. | • | • |
| Epilog Job Manager: Job management and workflow software - easily organize, edit, save and print. | • | • |
| Super-Silent™ Cooling Fans: Quiet operation suitable for office environments. | • | • |
| Easy-Access Drop-Down Door: Front access door for the laser system. | • | • |
| Removable Back Exhaust Panel: Provides easy cleaning of the exhaust plenum. | • | • |
| Radiance™ Beam-Enhancing Optics: Higher resolution optics for detailed engraving. | • | • |
| Emergency Stop Button: Stop the laser immediately with this front-positioned button. | • | • |
| Compatibility with Rotary Attachment: Engrave cylindrical objects with the optional rotary. | • | • |

INCLUDED

ADVANCED MOTION CONTROL

The Fusion M2's motion control system achieves the best edge quality on laser-cut acrylic that we've ever seen on a flying-optic laser system. The premier motion control also provides the fastest cutting on thin materials with improvements in cutting speeds up to 150% on .125" (3 mm) wood!

HIGH-SPEED, BRUSHLESS SERVO MOTORS

These robust motors provide the industry's highest resolution at 16,000 encoder counts per revolution. The Fusion M2's high-speed, brushless servo motors are more robust than ever before. These powerful, industrial motors are built to withstand the most rigorous engraving jobs while maintaining a low operating temperature.

JOYSTICK CONTROL

The intuitive joystick control on the M2 allows you to easily raise and lower the table, move and reset your home position, use the jog feature and much more. You can even fire the laser directly from the control panel. Additionally, this user-friendly control allows you to quickly and easily access all of the menu functions within the laser.

CUT DIRECTLY FROM THE JOYSTICK

Want to cut a piece of scrap material? It's never been easier than with our Joystick Cutting feature. Engage the laser with the press of a button, then use the joystick control to move the laser head wherever you want. Cut through materials, or even test your skill by writing your name!

INCREDIBLY STRONG, RIGID CHASSIS

By designing an all-steel chassis that can withstand the fastest laser head movement, we've improved our motion control system, cutting quality and even our engraving speed. The chassis on the Fusion M2 is 10 times stronger than any of our other systems and it shows!

DROP-DOWN FRONT DOOR & REMOVABLE EXHAUST PANEL

Easily place a large part or tray of parts through the hinged, front-access door. This safety-interlocked door provides fast and efficient parts placement and removal. You can also easily remove the exhaust panel with a few simple screws for easy access to clean the back of the system.



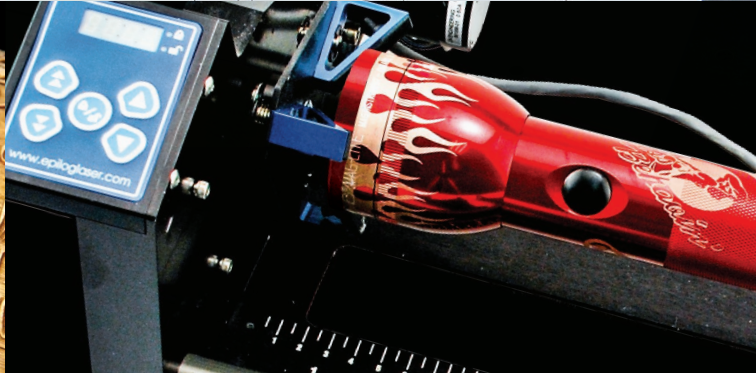
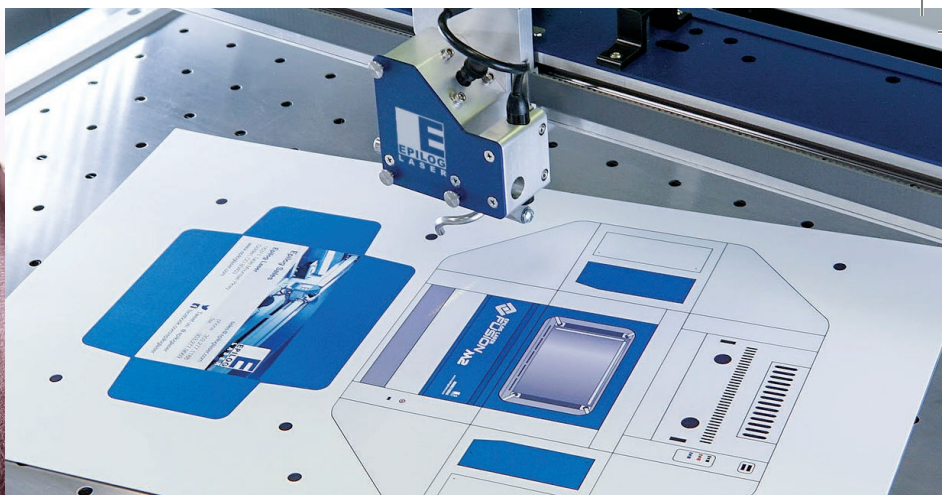

OPTIONAL

DUAL SOURCE CONFIGURATION

Do you want to maximize your system's versatility? Choose the Dual laser source to add CO₂ and fiber sources in the same system! For dual configurations, choose between a 50, 60 or 75 watt CO₂ laser and match it with a 20, 30 or 50 watt fiber laser. Pick the combination that is best for your application.

THE EVIEW™ CAMERA MODULE

The Fusion M2's camera positioning option adds three cameras to your system for the most accurate cuts around printed images on wood, acrylic, cardstock, and more. The cameras also provide a real-time preview of the cutting table. The cut lines from your printed graphic will overlay the image to show a preview of where the laser cuts will occur.

VECTOR GRID

Incorporate the gridded cutting table when cutting through materials. By raising the materials off the table when cutting you'll be able to reduce any back-side burning on the material.

AIR COMPRESSOR

Designed to work with the included Air Assist feature, the compressor will direct a constant stream of air to the cutting surface to remove heat and combustible gases.

ROTARY ATTACHMENT

Epilog offers two types of Rotary Attachments for the Fusion M2 Laser Series. The Standard Rotary is great for general-purpose cylindrical shapes, including glasses, mugs and wine bottles. We offer the 3-Jaw Chuck Rotary Attachment for more demanding applications when you need to mechanically clamp a cylinder or oddly shaped, non-cylindrical item.

VECTOR PIN TABLE

Incorporates moveable pins designed to raise and support the areas of a piece of material that won't be cut. This helps ensure you receive the cleanest edge cut quality.

CO₂ LENS

1.5" Lens: Use when engraving small text and the highest-resolution images.

4.0" Lens: Use when engraving within a recessed area of a product and cutting thicker materials.

Cone Lens: Use when cutting through thick hardwoods and acrylics.

FIBER LENS

5.0" Lens: Use when engraving slightly curved surfaces.

8.0" Lens: Use for the greatest depth of field on the fiber laser systems.

G2 GALVO LASER SYSTEM



G2 GALVO

- Our fastest and largest work area for metals
- Laser source: air-cooled, pulsed fiber laser
- 24" x 24" (609 x 609 mm) work area
- 30 or 50 watt fiber laser
- Adjustable engraving field area

REMOVES SIZE LIMITATIONS

Traditional galvo metal etching systems have had two tradeoffs - you were either constrained to a small work area based on the limits of a stationary mirror with a set focus range or you needed to have the safety capabilities to have a Class IV open laser in your business. We've removed this limitation by adjusting focal height and beam delivery with a unique telescoping lens technology for safely engraving the largest parts in an enclosed cabinet.

INCLUDED FEATURES

G2

| | |
|---|---|
| Made-in-the-USA Quality: Designed, engineered, and built in Golden, CO. | • |
| Epilog Job Manager: Job management and workflow software - easily organize, edit, save and print. | • |
| Laser Dashboard™: Our print driver where you can choose from many engraving features. | • |
| Easy Access Sliding Doors: Wide-opening slider doors with 25" (635 mm) access to the marking field. | • |
| Servo Encoder Motorized Table: Allows for precise focus, programmable from the print driver. | • |
| Color Mapping: Change your speed and power by using color settings. | • |
| Pulsed Fiber Laser: Highest quality laser source produced by IPG Photonics. | • |
| Field-Tunable Focus: Factory set focus with the ability to finetune in the field based on the required mark. | • |
| Networking Choices: USB and Ethernet connections, or connect wirelessly with a router. | • |
| Repositionable Edge Guides: Adjust the edge guides for easy part placement. | • |
| Visible Red Trace Feature: Trace your engraving area for accurate marking placement. | • |
| Hatching Patterns: Multiple fill patterns and angles to optimize your marking. | • |
| Laser-Safe View: Large laser-safe windows and LED-lit cabinet area. | • |

EASY TO USE

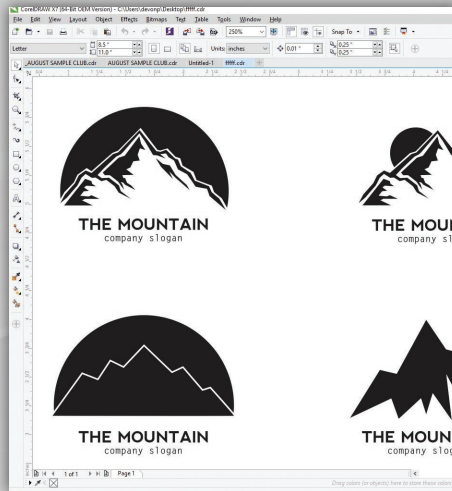

MOVABLE FIELDS

With the unique design of the Epilog G2 there is no need to change lenses to change the field size. You can set the engraving field directly from the keypad without mechanical changes to the system.

SOFTWARE

Print to the laser directly from almost any Windows®-based software package including AutoCAD, SolidWorks, barcoding and serialization software, or even graphics programs like CorelDRAW and Illustrator. Operators can start using the system without special training on proprietary software packages.

ENGRAVING & ETCHING

You can produce a variety of marks with easily adjustable speed, power, frequency and focus variables. Whether you require a deep etching, a surface etch, or a richer annealed mark, you can use our quick reference guide to find the right settings for your product.

SPEEDS

Dual-pivoting mirrors make microscopic adjustments to direct the laser beam to the table for incredibly fast, high-resolution engraving.

FOCUS

Telescoping dynamic lens moves on the horizontal axis to adjust the focus distance for a consistent spot size over a large engraving area.

24X24

16X16

4X4

ADJUSTABLE TABLE

Quickly change the table between 4" x 4" (101 mm), 16" x 16" (406 mm), and 24" x 24" (609 mm).

TECHNICAL SPECIFICATIONS



| | Zing 16 | Zing 24 |
|---|--|--|
| Max Engraving Area | 16" x 12" (406 x 305 mm) | 24" x 12" (610 x 305 mm) |
| Max Material Thickness | 4.5" (114 mm) | 7.75" (197 mm) |
| Laser Tube Wattages | 30 and 40 watt, CO ₂ , air-cooled, metal Waveguide tube, 10.6 micrometers. | 30, 40, 50 and 60 watt, CO ₂ , air-cooled, metal Waveguide tube, 10.6 micrometers. |
| Standard Features | Air Assist, motorized table, Red Dot Pointer, 2" (51 mm) focus lens, relocatable home, Laser Dashboard, shielded roller bearing assembly, Super-Silent Cooling Fans. | Zing 16 features, plus Radiance High-Definition Optics, easy access drop-down door, laser head parking, Super-Silent Cooling Fans. |
| Print Driver & Software | Laser Dashboard™, Epilog Job Manager™ | |
| Internal Memory | Store multiple files up to 64 MB. Rolling buffer allows files of any size to be engraved. | |
| Operating Modes | Optimized Raster, Vector and Combined mode. | |
| Motion Control System | High-speed micro stepper motors. | |
| X-Axis Bearings | Shielded roller bearing assembly on a ceramic-coated aluminum guide rail. | |
| Belts | Advanced B-style Kevlar belts. | |
| Resolution | User-controlled from 100 to 1000 dpi. | |
| Speed and Power Control (engraving depth) | Computer-controlled speed and power in 1% increments up to 100%. Color mapping feature links Speed, Power, Frequency, and Raster/Vector mode settings to any RGB color. | |
| Print Interface | 10Base-T Ethernet or USB connection. Compatible with Windows XP/Vista/7/8/10. | |
| Size (W x D x H) | 28.75" x 22.125" x 11.75" (730 x 562 x 298 mm) | 38" x 27.25" x 15" (965 x 692 x 381 mm) |
| Weight | 95 lbs. (43 kg) | 140 lbs. (64 kg) |
| Electrical Requirements | Auto-switching power supply accommodates 110 to 240 volts, 50 or 60 Hz, single phase, 15 amp AC. | |
| Ventilation System | 350 - 400 CFM (595 - 680 m ³ /hr) external exhaust to the outside or internal filtration unit is required. There is one output port, 4" (102 mm) in diameter. | |
| Laser System Classification | Class 2 Laser Product - 1 mW CW MAXIMUM 600-700 nm | |

Technical specifications and product configurations subject to change without notice.



| Mini 18 | Mini 24 | Helix | FiberMark 24 |
|--|--|---|---|
| 18" x 12" (457 x 305 mm) | 24" x 12" (610 x 305 mm) | 24" x 18" (610 x 457 mm) | 24" x 12" (610 x 305 mm) |
| 4" (102 mm). Remove table for 6" (152 mm) depth and 17.5" x 10" (444 x 254 mm) engraving area. | 5.5" (140 mm). Remove table for 8" (203 mm) depth and 23.5" x 11.75" (597 x 298 mm) engraving area. | 8.5" (216 mm). Remove table for 11" (279 mm) depth and 23.5" x 17" (597 x 432 mm) engraving area. | 5.0" (127 mm) |
| 30 and 40 watt, CO ₂ , air-cooled, metal Waveguide tube, 10.6 micrometers. | 30, 40, 50, and 60 watt, CO ₂ , air-cooled, metal Waveguide tube, 10.6 micrometers. | 30, 40, 50, 60, and 75 watt, CO ₂ , air-cooled, metal Waveguide tube, 10.6 micrometers. | 20, 30, or 50 watt, Fiber, air-cooled, includes collimator. 1065 nm. Beam quality: M2 < 1.1 |
| Air Assist, Auto Focus, Red Dot Pointer, Integrated Vector Grid & Vacuum Table, 2" (51 mm) focus lens, relocatable home position, permanent job save with 10, 2 MB files, easy-access drop-down door, Super-Silent Cooling Fans. | Radiance™ High Definition Optics, Air Assist, Auto Focus, Red Dot Pointer, Integrated Vector Grid & Vacuum Table, 2" (51 mm) focus lens, relocatable home position, permanent job save with 10, 2 MB files, easy-access drop-down door, Super-Silent Cooling Fans. | Radiance™ High Definition Optics, Air Assist, Auto Focus, Red Dot Pointer, Integrated Vector Grid & Vacuum Table, 2" (51 mm) focus lens, relocatable home position, permanent job save with 10, 2 MB files, integrated floor stand. | Relocatable home position, variable focus control, work table of .5" (12.7 mm) tool plate with integrated vacuum hold-down capability, internal LED lighting, front and top access doors. |
| Laser Dashboard™, Epilog Job Manager™ | | | |
| Store multiple files up to 64 MB. Rolling buffer allows files of any size to be engraved. | | | |
| Optimized Raster, Vector and Combined mode. | | | |
| High-speed, continuous-loop, DC servo motors using linear and rotary encoding technology for precise positioning. | | | |
| Ground and polished stainless steel long-lasting bearing system. | | | |
| Advanced B-style double-wide Kevlar precision drive belts. | | | |
| User-controlled from 75 to 1200 dpi. | | | |
| Computer-controlled speed and power in 1% increments up to 100%. Color mapping feature links Speed, Power, Frequency, Raster/Vector mode, and Air Assist On/Off settings to any RGB color. | | | |
| 10Base-T Ethernet or USB connection. Compatible with Windows XP/Vista/7/8/10. | | | |
| 27.8" x 26" x 13.5" (706 x 660 x 343 mm) | 34.5" x 26" x 16" (876 x 660 x 406 mm) | 36.5" x 32" x 39.8" (927 x 813 x 1011 mm) | 34.5" x 24.5" x 16" (876 x 622 x 406 mm) |
| 70 lbs. (32 kg) - 100 lbs. (45.5 kg) with stand | 90 lbs. (41 kg) - 120 lbs. (55 kg) with stand | 180 lbs. max (82 kg) | 120 lbs. (55 kg) without stand |
| Auto-switching power supply accommodates 110 to 240 volts, 50 or 60 Hz, single phase, 15 amp AC. | | | |
| 350 - 400 CFM (595 - 680 m ³ /hr) external exhaust to the outside or internal filtration unit is required. There is one output port, 4" (102 mm) in diameter. | | | |
| Class 2 Laser Product - 1 mW CW MAXIMUM 600-700 nm | | | |

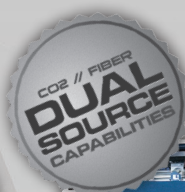

| Fusion M2 32 (CO ₂) | | Fusion M2 32 (Fiber) | | Fusion M2 40 (CO ₂) | | Fusion M2 40 (Fiber) | | G2 Galvo | | |
|--|--|---|--|--|--|---|--|--|--|--|
| 32" x 20" (812 x 508 mm) | | | | 40" X 28" (1016 X 711 mm) | | | | 24" x 24" (609 x 609 mm) | | |
| 13.5" (343 mm) (2" lens) | | 12.5" (318 mm) (3" lens) | | 13.25" (337 mm) (2" lens) | | 12.25" (311 mm) (3" lens) | | 4" x 4" (101 mm) table: 36.25" (921 mm) 16" x 16" (406 mm) table: 26" (660 mm) 24" x 24" (609 mm) table: 15.75" (400 mm) | | |
| Dual Source 12.5" (318 mm) (3" lens) | | | | Dual Source 12.25" (311 mm) (3" lens) | | | | 30 or 50 watt Fiber, air-cooled. | | |
| 30, 40, 50, 60, 75, or 120 watt, CO ₂ , air-cooled, metal Waveguide tube, 10.6 micrometers. | | 20, 30, or 50 watt, Fiber, air-cooled, includes collimator. 1064 nm. Beam quality: M2 < 1.1 | | 30, 40, 50, 60, 75, or 120 watt, CO ₂ , air-cooled, metal Waveguide tube, 10.6 micrometers. | | 20, 30, or 50 watt, Fiber, air-cooled, includes collimator. 1064 nm. Beam quality: M2 < 1.1 | | | | |
| Radiance™ High Definition Optics, Air Assist, Red Dot Pointer, relocatable home position, LED lighting, integrated floor stand, brushless servo motors, Super-Silent Cooling Fans, joystick controls, removable exhaust. | | | | | | | | | | |
| Dual Source Fusion M2 32 & Fusion M2 40 Available with combination of 50, 60, or 75-watt CO ₂ and 20, 30 or 50-watt Fiber Laser. | | | | | | | | | | |
| Laser Dashboard™, Epilog Job Manager™ | | | | | | | | | | |
| Store multiple files up to 128 MB. Rolling buffer allows files of any size to be engraved. | | | | | | | | | | |
| Optimized Raster, Vector and Combined mode. | | | | | | | | | | |
| High-speed, continuous-loop, brushless DC servo motors using rotary encoding technology for precise positioning. | | | | | | | | | | |
| Ground and polished stainless steel, teflon-coated, self-lubricating bearings. | | | | | | | | | | |
| Advanced B-style Kevlar belts (x-axis) and steel cord (y-axis). | | | | | | | | | | |
| User-controlled from 75 to 1200 dpi. | | | | | | | | | | |
| Computer-controlled speed and power in 1% increments up to 100%. Color mapping links Speed, Power, Frequency, Focus, and Raster/Vector mode settings to any RGB color. | | | | | | | | | | |
| 10Base-T Ethernet or USB connection. Compatible with Windows XP/Vista/7/8/10. | | | | | | | | | | |
| 52.5" x 33.75" x 40.75" (1334 x 857 x 1035 mm) 37.75" (959 mm) deep with exhaust plenum. | | | | 60.5" x 41.25" x 42.25" (1537 x 1048 x 1073 mm) 43" (1092 mm) deep with exhaust plenum. | | | | 33" x 43.75" x 71.1" (838 x 1111 x 1806 mm) | | |
| 500 lbs. (227 kg) Dual Source 536 lbs. (243 kg) | | | | 643 lbs. (292 kg) Dual Source 679 lbs. (308 kg) | | | | 415 lbs. (188.241 kg) | | |
| Auto-switching 110 to 240 volts, 50 or 60 Hz, single phase, 15 amp AC. | | | | | | | | | | |
| 650 CFM (1104 m ³ /hr) external exhaust to the outside or internal filtration unit is required. There are two output ports, 4" (102 mm) in diameter. | | | | | | | | | | |
| Class 2 Laser Product - 1 mW CW MAXIMUM 600-700 nm | | | | | | | | | | |
| Computer-controlled speed and power in 1% - 100% increments. | | | | | | | | | | |
| 10/100 Ethernet with Auto-MDIX. Compatible with Vista/7/8/10. | | | | | | | | | | |
| Auto-switching 110 to 240 volts, 50 or 60 Hz, single phase, 15 amp AC. | | | | | | | | | | |
| 650 CFM (1104 m ³ /hr) external exhaust to the outside or internal filtration. Two 4" (102 mm) ports. | | | | | | | | | | |
| Class 2 - 1 mW CW MAXIMUM 600-700 nm. | | | | | | | | | | |

WHY CHOOSE EPILOG LASER?

MOST DETAILED ENGRAVING

Only Epilog's laser systems can engrave the highest resolutions at the fastest speeds. The depth, darkness, speed, and precision of engraving are unbeatable.

INDUSTRIAL MACHINE QUALITY

Epilog only utilizes the highest-quality parts on every system we manufacture. Industrial belts, bearings, and motors are the keys to long-lasting systems that withstand the most rigorous use.

SAFETY

We only design class 2 laser systems that are completely safe for you and your team to use every day without worry. Systems are enclosed in interlocked cabinets that turn off the laser as soon as the door is open. Our systems are safe enough for a child to use in a school environment or for your employee after a long day on the job.

AFTER SALES SUPPORT

From our popular Sample Club that is filled with downloadable files to create with your laser, to our outstanding Technical Support team, we've got the most resources to help you succeed.

Get **MORE INFO** or
SCHEDULE A DEMO!

888.437.4564 | sales@epiloglaser.com
www.epiloglaser.com





MADE IN USA

EPILOGLASER.COM

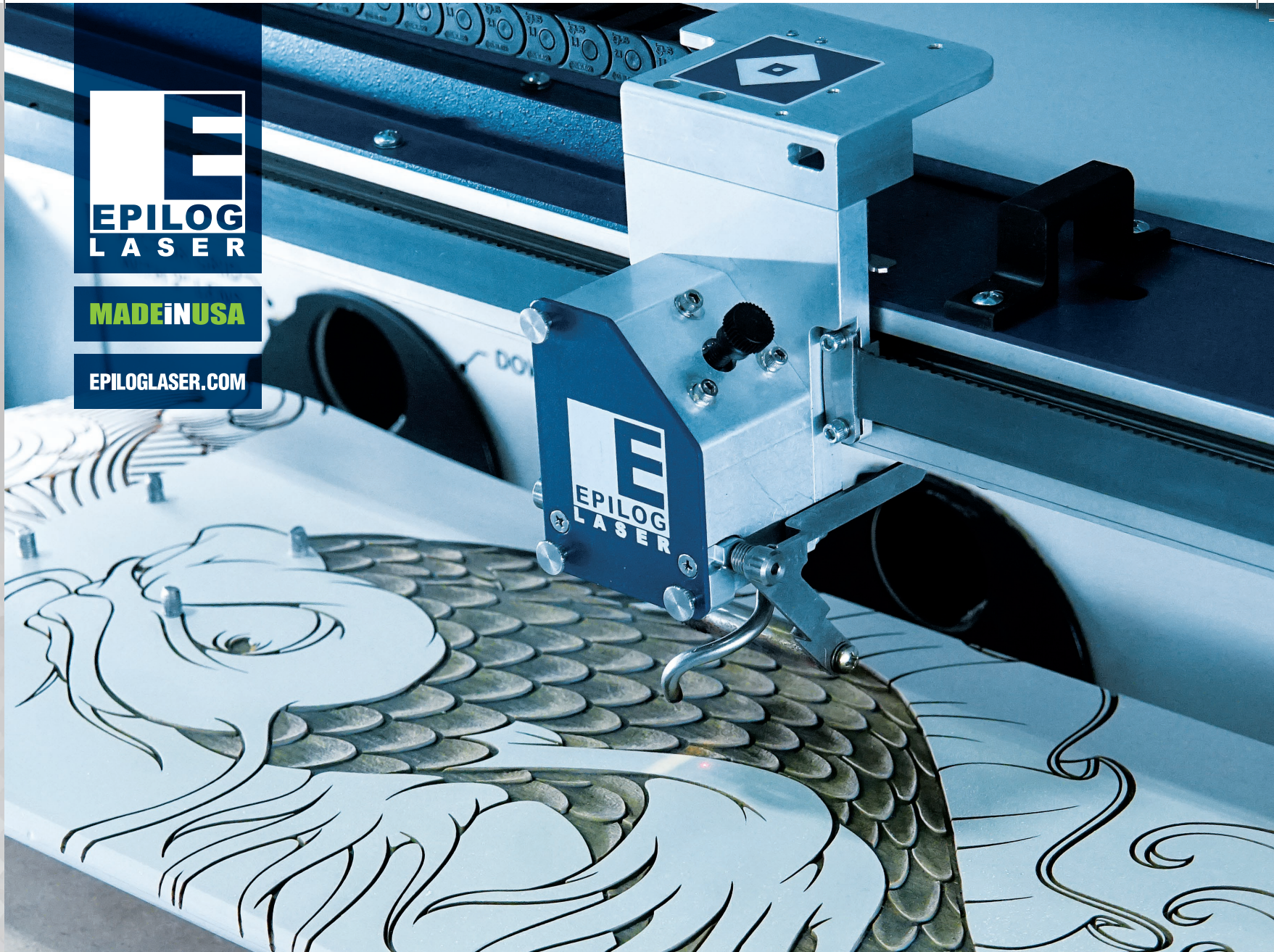

LASER RADIATION
DO NOT STARE INTO BEAM
CLASS 2 LASER PRODUCT
1 mW CW MAXIMUM 600-700 nm

888.437.4564 | sales@epiloglaser.com | 16371 Table Mountain Parkway, Golden, CO, 80403

For system pricing information and to schedule your personal demonstration, contact your **local distributor.**

